

Accessories: Mounting unit BES 12.0-KB-3-F

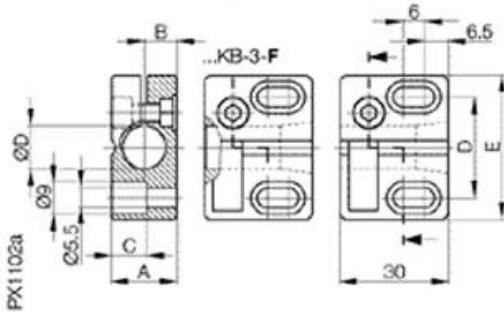

Common Data

Version
Usable with

Clamp
clamp with positive stop for
sensors M12 flush

	A	B	C	D	E	ØD
BES 12,0-KB-3	18	9	9,7	28	40	12
BES 18,0-KB-3	24	12	13,5	28	40	18
BES 12,0-KB-3-F	18	9	9,7	28	40	12
BES 18,0-KB-3-F	24	12	13,5	28	40	18
BES 30,0-KB-3-F	36	18	19,5	42	54	30

Mechanical Data

Measurements WxHxD or Dia x D
Material
Mounting

40x30x18
PA6 GK
with 2 screws M5

Datasheet number::

Definitions see general catalog.
If not otherwise noted, ratings according to
IEC 60947-5-2 (DIN EN60947-5-2)

Balluff GmbH
Schurwaldstrasse 9
73765 Neuhausen a.d.F.
Phone (07158) 173-0 Fax (07158) 5010

Datenblatt by CD-ROM - 04/2007

BALLUFF
sensors worldwide